

PARTZSCH

SPEZIALDRÄHTE

**LIVE WIRES
AT YOUR
SERVICE**



CHRISTIAN PARTZSCH

» The special wires manufactured with passion and expertise at PARTZSCH Spezialdrähte GmbH are up to meet any challenge. Over many years, we have built up extensive know-how in order to realise individual production requirements for copper wires in a wide range of dimensions and insulation designs. In our work, we benefit from our close collaboration with engineers from the development, design and production departments in electrical engineering.

Our customers in the fields of renewable energies, electromobility, the rail sector and transformer, generator and electric motor manufacturing have been relying on our high-quality special wires for years. We hope you will, too.

We look forward to working with you! «

YOUR ADVANTAGES AT A GLANCE

- Many years of experience in wire production
- Uncomplicated and flexible order processing
- Fast and on-time deliveries
- One of the most modern machinery bases in Europe
- Swift decision-making processes
- Certified acc. to DIN ISO 9001:2015
- Highest quality standard – made in Germany
- Part of a successful company group

PARTZSCH SPEZIALDRÄHTE

Live wires at your service: PARTZSCH Spezialdrähte has been manufacturing and supplying copper wires, as an essential component for electrical machines and drives, since the 1990s. Over the years, we have grown continuously into one of the most important players on the copper wire market.

We produce and finish around 10,000 tonnes of copper wire each year. As part of this process, the bare wires can be insulated with a variety of materials, such as mica sheet, polyimide sheet, paper, enamel or glass filament. Combinations of different insulation materials are also possible. Your individual requirements are our top priority, and we manufacture products which meet your precise specifications. Continuous quality verification on our modern machines and permanent monitoring with the aid of dedicated test stands enable us to guarantee the observance of all critical parameters. Our quality management system is certified to DIN EN ISO 9001:2015 and is likewise a guarantee for optimum production results. Individual customer service and the fastest possible delivery times are for us a matter of course.

OUR PRODUCTS AND SERVICES

Manufacture of bare copper wires in flat or round design with various insulations



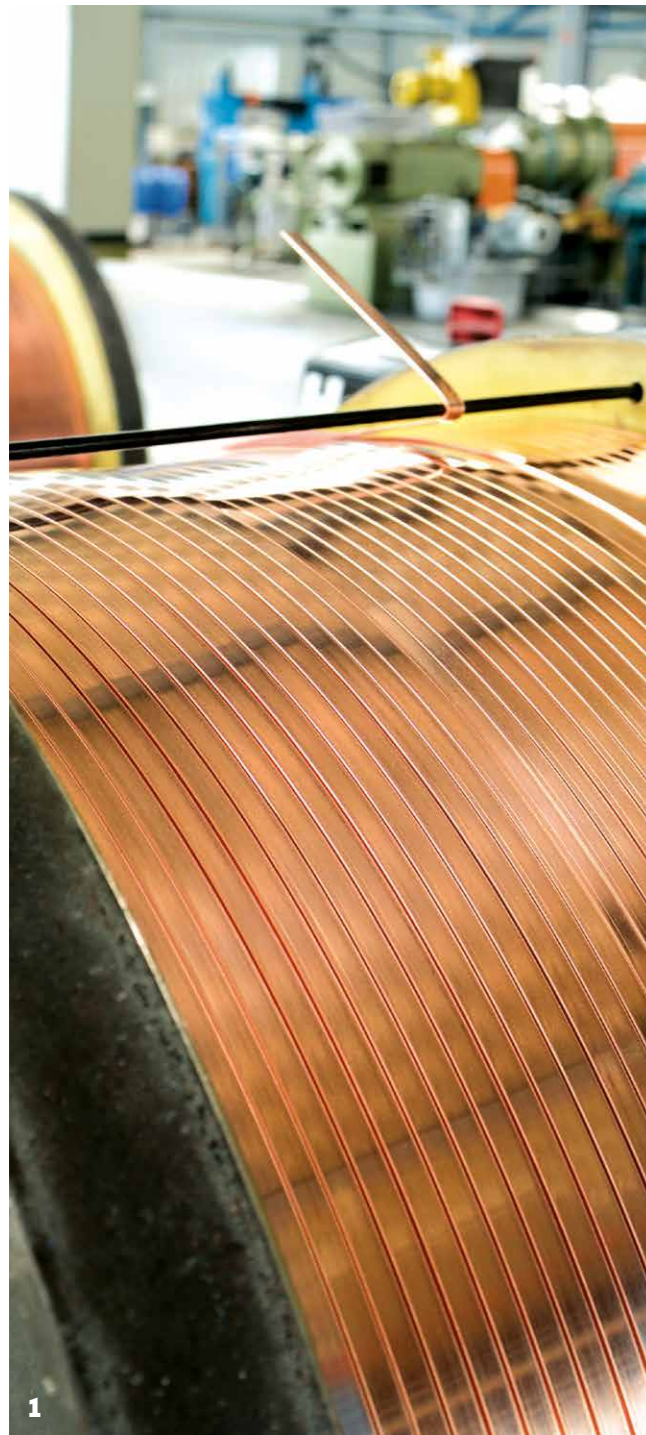

1



2



3



4



5

- 1 Rolled bare wire
- 2 Annealing furnace systems
- 3 Wire enamelling machines
- 4 Systems for insulation of rectangular wires with mica sheet
- 5 Bare round wire

PRODUCTION AT THE HIGHEST LEVEL

Our bare copper wires are manufactured in our modern production centre in a series of finely tuned work steps. The excellent properties of the copper used permit significantly stronger shaping without intermediate annealing. To relieve any stress peaks which occur nevertheless, and furthermore to achieve the application-specific deformability of the wire, we perform subsequent heat treatment in a specialised workshop comprising annealing furnace systems and cooling stations. The deformability attained is at the same time a quality feature of our copper wires. All our wires are manufactured according to DIN standards and correspond to R200 quality as standard. After consultation your specific wishes can also be realised.

OUR COMPREHENSIVE STANDARD PROGRAM

- Manufacturing according to DIN standard
- Rectangular wires: Width 1.00 – 30.00 mm
Thickness 0.80 – 7.00 mm
- Round wires: Diameter 0.50 – 11.00 mm
- Customised wire dimensions on request

Wire enamelling

Where requested by the customer, we can apply wire enamelling of different layer thicknesses. The wire enamelling we manufacture with the lowest manufacturing tolerances for round wires from 0.50 to 2.60 mm diameter as well as for rectangular wires with a width from 3.35 to 14.00 mm and a thicknesses from 0.80 to 6.00 mm.

Wire insulation with the most varied tape types

We insulate rectangular and round wires using a range of insulation materials, for example polyimide sheet, mica sheet, paper or aramid paper. Wire insulation using paper or film is offered for round wires in diameters from 0.85 to 6.00 mm and for rectangular wires in widths from 3.35 to 25.00 mm and thicknesses from 1.00 to 7.00 mm.

Wire insulation with glass filament or mixed yarn

Wires which are exposed to high stresses, vibration, temperatures or temperature fluctuations are usually wound in suitable yarns to resist such influences. For these purposes, we use glass-fibre and mixed yarns (Daglas) with various numbers of individual threads, which can be impregnated with epoxy resin or enamelled polyester imide. These specifications enable us to manufacture wires in the most varied versions to meet your individual wishes and demands.

SPECIAL WIRES IN ALL VARIANTS

Every year, we supply around 10,000 tonnes of wire for the most varied applications to customers all over the world. Our experienced development and design engineers have acquired a wealth of expertise in wire manufacturing and enable us to promise the best quality at all times. Given the beneficial properties of the material, we have specialised in the manufacturing and finishing of wires made from copper ever since the company was founded. Copper offers not only outstanding electrical conductivity, but also optimum strength and workability.

In accordance with your specifications, we produce round and rectangular wires in drawn and rolled versions and in the most varied dimensions. These wires can be finished to either the DIN standard or individual customer specifications – whichever best suits your needs.



OVERVIEW OF OUR ASSORTMENT OF WIRES

	Bare wires (in mm)	Rectangular and round wires insulated with polyimide sheet (in mm) *	Rectangular and round wires insulated with mica sheet (in mm) *	Rectangular and round wires insulated with paper or aramid paper (in mm) *	Rectangular and round wires enamelled (in mm)	Rectangular wires insulated with glass filament and/or mixed yarn (in mm) *	Litz wire insulated with mica and/or PET sheet
Conductor material	Rectangular wire Round wire	Rectangular wire Round wire	Rectangular wire Round wire	Rectangular wire Round wire	Rectangular wire Round wire	Rectangular wire	Single round wire
Rectangular wire ** acc. to DIN EN Width (W) Thickness (T)	W: 1.00 ... 30.00 T: 0.80 ... 7.00	W: 1.00 ... 16.00 T: 0.80 ... 7.00	W: 1.00 ... 25.00 T: 0.80 ... 7.00	W: 3.35 ... 20.00 T: 1.00 ... 7.00	W: 1.00 ... 14.00 T: 0.80 ... 6.00	W: 3.35 ... 20.00 T: 1.00 ... 5.00	Single wire Cross section of litz wire: 6 mm ² ... 70 mm ²
Round wire acc. to DIN EN	Ø: 0.50 ... 11.00	Ø: 2.00 ... 6.00	Ø: 0.85 ... 6.00	Ø: 2.00 ... 6.00	Ø: 0.50 ... 2.60		
Insulation / design		<ul style="list-style-type: none"> • Polyimide sheet, FEP coated and hot-sealed, also corona resistant (TI 220°C) 	<ul style="list-style-type: none"> • Mica with PET-liner (TI 155°C) • Mica with PI-liner (TI 185°C) • Mica with glass fibre liner (TI on request) • Combinations with enamelled wire and/or PET sheet possible *** 	<ul style="list-style-type: none"> • Kraft paper • Nomex® (TI 120°C) • Possible in combination with enamelled 	<ul style="list-style-type: none"> • Rectangular wire • Enamel Polyamidimide acc. to DIN EN (TI 220°C) • Round wire • Base coat Polyesterimide, Over coat Polyamidimide acc. to DIN EN (TI 200°C) • UL-file: MW35-C 	<ul style="list-style-type: none"> • Combinations with bare, enamelled or polyimide-sheet insulated wires possible (TI 155°C ... 180°C) • Glass filament and/or mixed yarn, impregnated 	<ul style="list-style-type: none"> • PET sheet • Mica sheet (TI 155°C) ***
Increase		Acc. to the customer's specifications	Acc. to the customer's specifications	Acc. to the customer's specifications	• Class 1, 2 and 3 acc. to DIN EN or to the customer's specifications	Acc. to the customer's specifications	Acc. to the customer's specifications
Number of layers / taping		• 1 ... 2 layers opposite directions	• 1 ... 4 layers same and opposite directions ***	• 1 ... 8 layers same and opposite directions ***		• 1 ... 2 layers opposite directions	• 1 ... 3 layers, same direction • 2 layers, opposite direction
Overlap		Steplessly variable, max. 75%	Edge to edge, steplessly variable, max. 75%	Edge to edge, steplessly variable • Rectangular wire max. 80% • Round wire max. 50%			Steplessly variable, min. 30% to max. 80%
Application examples	<ul style="list-style-type: none"> • Conductor material for further insulation • Rotor bars 	<ul style="list-style-type: none"> • Traction motors • Special-purpose motors • Motors for high-temperature applications 	<ul style="list-style-type: none"> • High- and low-voltage machines • Frequency-converter-proof extraction • Gas motors • Fire resistant cables • Transformers 	<ul style="list-style-type: none"> • Transformer windings • Reactors 	<ul style="list-style-type: none"> • Motors • Generators • Transformers 	<ul style="list-style-type: none"> • Traction motors • Generators • High-voltage motors • Special-purpose motors 	<ul style="list-style-type: none"> • HF motors • Reactors • Transformers

* Insulated round wire is not suited for drawing-in technology! ** Feasibility depends on the W/T ratio *** Further variants possible at the customer's specifications

OUR ASSORTMENT OF SPOOLS

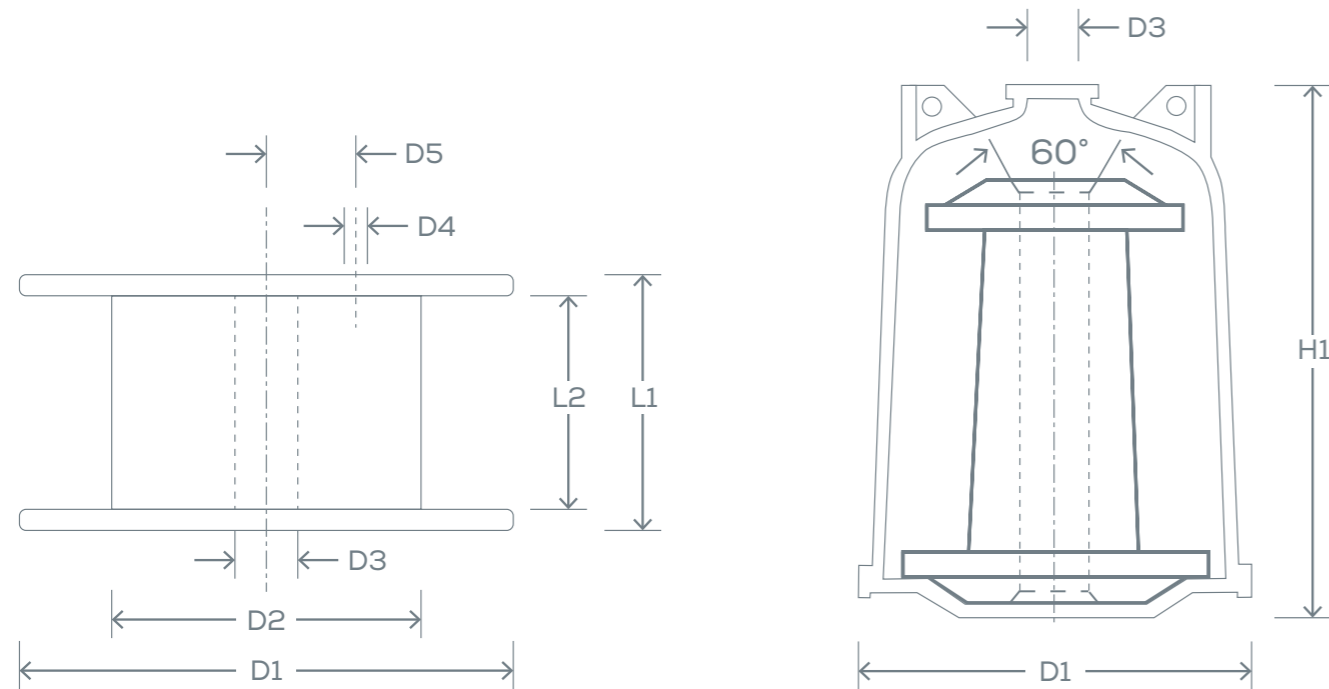

Cylindrical spools

Type	Material	D1 (in mm)	D2 (in mm)	D3 (in mm)	D4 (in mm)	D5 (in mm)	L1 (in mm)	L2 (in mm)	Deadweight	Weight
K250	Plastic	250	160	22	13	43	200	160	Approx. 1.5 kg	Approx. 20 kg
K355	Plastic	355	225	35	26	80	200	160	Approx. 3.5 kg	Approx. 40 kg
K500	Plastic	500	320	35	26	80	250	180	Approx. 8 kg	Approx. 100 kg
VM710	Plastic	710	500	55	26	140	250	180	Approx. 15 kg	Approx. 200 kg
VM630	Plastic	630	315	44	26	80	230	180	Approx. 9.5 kg	Approx. 200 kg
VM800	Plastic	800	400	85	26	140	320	250	Approx. 20 kg	Approx. 400 kg
H1150	Wood	1,150	630	80	22	80	340	280	Approx. 52 kg	Approx. 1,000 kg
ND630	Steel	630	355	127	28	140	445	405	Approx. 64 kg	Approx. 350 kg
EGE762	Steel	762	355	127	28	140	550	500	Approx. 107 kg	Approx. 950 kg

Cylindrical barrelled delivery spools acc. to IEC 60264-2, DIN 46399 or 46395 and other customised specifications are possible upon request.

Long spools with container

Typ	D1 (in mm)	H1 (in mm)	D3 (in mm)	Deadweight	Weight Cu
A250	315	500	100	4.7 kg	Approx. 45 kg
A315	400	630	100	9.1 kg	Approx. 90 kg
A400	500	800	100	16.0 kg	Approx. 180 kg

Long spools acc. to IEC 60264-3 with container acc. to IEC 60264-3-5



QUALITY IS MANUFACTURED, NOT SIMPLY MEASURED

Our credo: Quality is manufactured, not simply measured! This is the reason why the most important components for measuring are already installed on our machines. In addition, we perform initial sample and series tests with creation of the appropriate reports.

The overarching goal of our work is customer satisfaction. Accordingly, on-schedule delivery of a flawless quality product is one of our top priorities. Quality determines the thoughts and actions of our employees, and they contribute actively to continuous quality improvement along the whole process chain. The stipulations of ISO 9001:2015, in combination with individual customer specifications, form the basis of our work. Through internal audits and monitoring by an accredited certification body, our quality management system is evaluated with regard to its effectiveness, certified and adapted continuously to the current demands of the market – from initial goods intake through to final product delivery.

Mechanical tests

- Tensile strength
- Fracture strain
- Tests for the normalised offset yield stress
- Impact silence tests

Electrical tests

- Breakdown voltages (at room temperature, at increased temperature)
- Resistance tests

Profile tests

Testing of the ductility and bonding strength

Other tests

- Determination of the content of glass and binders
- Behaviour against solvents
- Thermal shock tests
- Determination of the degree of enamelling in the case of enamelled wires
- Tests in A/C chambers
- Special tests upon request

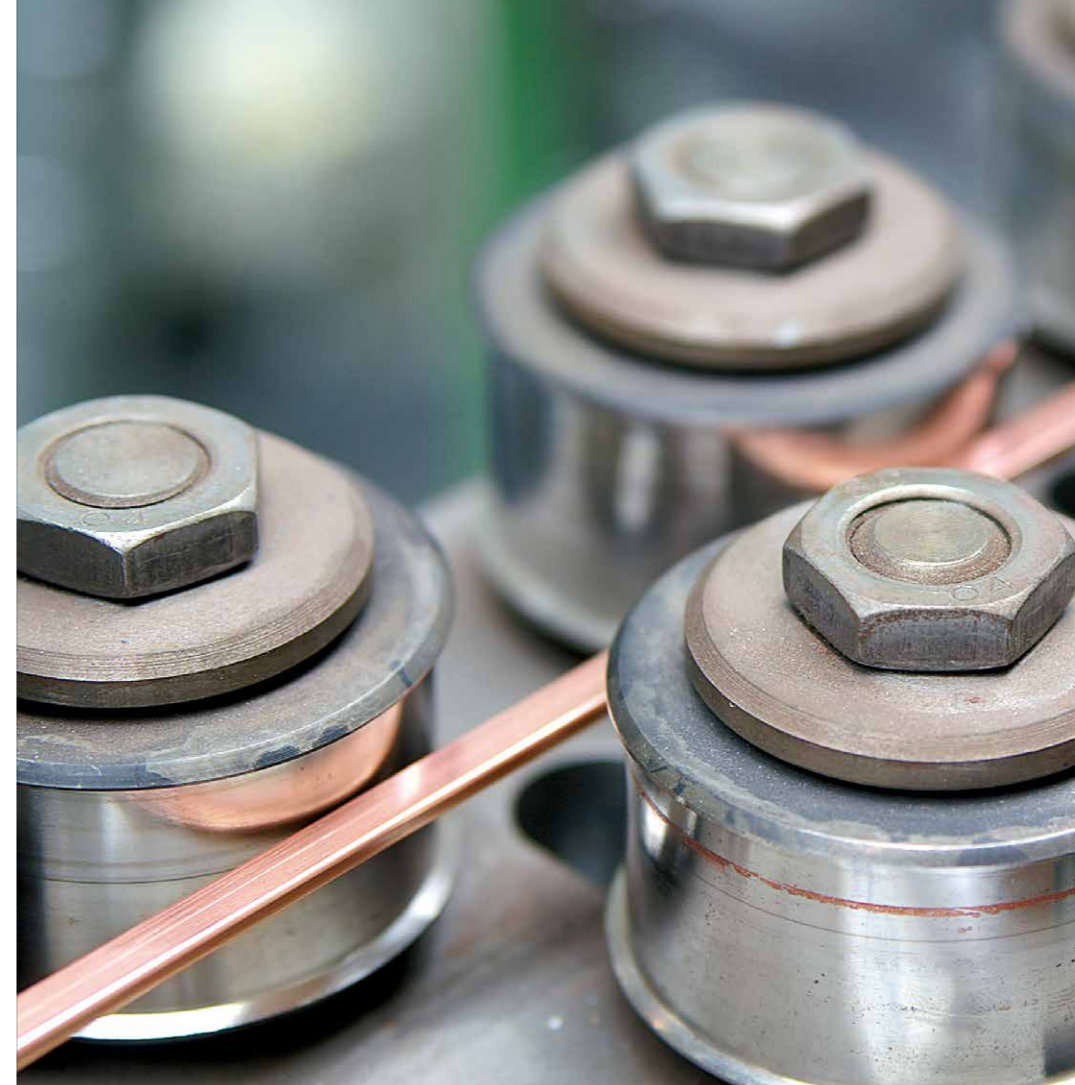

OUR QUALIFICATIONS

- Certified acc. to DIN EN ISO 9001:2015
- Verified »class A« supplier to numerous renowned companies

OUR MODERN FLEET OF MACHINES

- Rolling, continuous extrusion and drawing machines
- Annealing furnace systems
- Wire enameling systems
- Insulation systems for rectangular and round wires



Modern high-precision testing equipment ensures that our special wires are manufactured within the narrowest tolerances

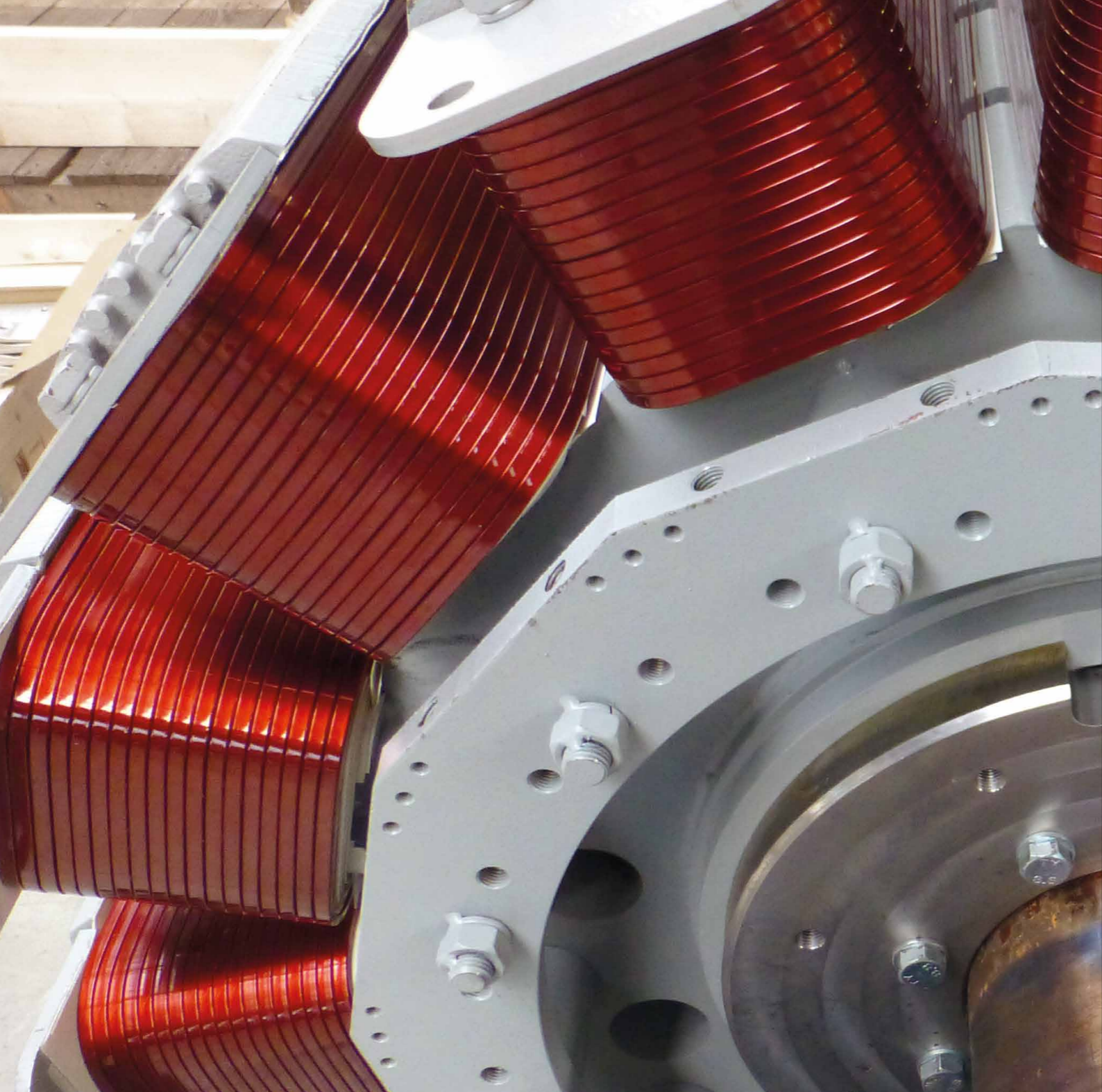

OUR WEBSHOP

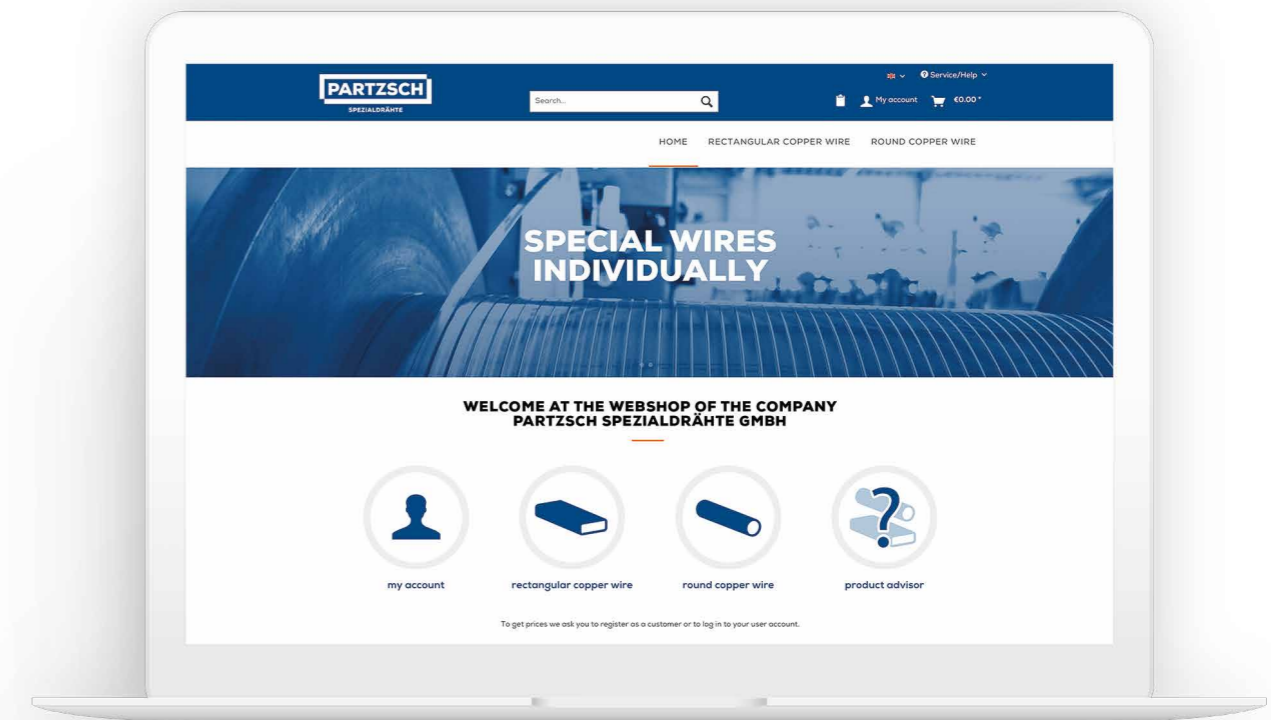

PARTZSCH special wires can be ordered quickly and simply at any time through our webshop. There, you will find all the most important products from our wide-ranging portfolio. If you are uncertain as to the optimum product for your individual needs, an online product adviser is available to help you. The webshop also simplifies follow-up orders for further quantities, because each ordered product can be saved for recall on a subsequent visit. And in case you are in a particular hurry, there is a matching option for »express orders«.

Test it for yourself!

shop.partzsch-spezialdraehte.de/en

Simple – Fast – Flexible – Secure

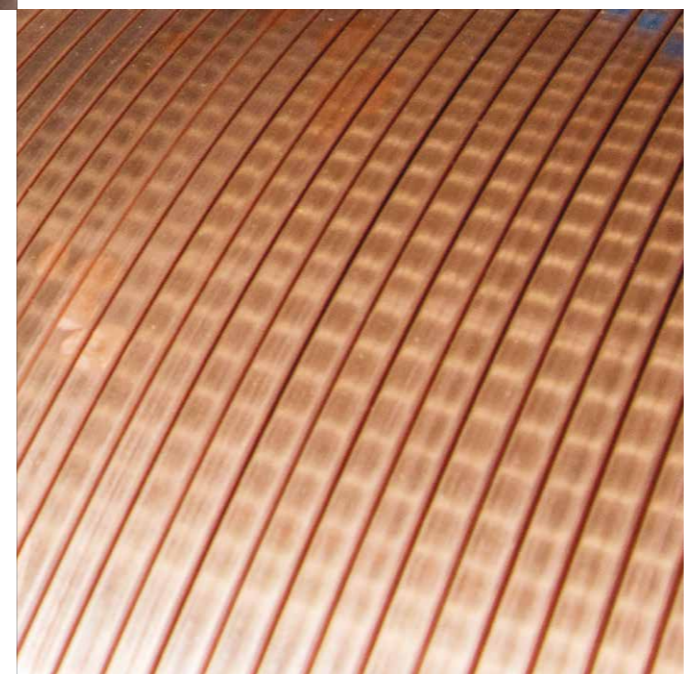

EVERYTHING FROM A SINGLE SOURCE – POWER FOR YOUR VISION



We as a member of the PARTZSCH Group can proudly say that the spirit of innovation meets the idea of service, enabling all customer wishes to become reality. As one of the leading mid-size companies in the electrical engineering branch, the PARTZSCH Group manufactures a broad spectrum of products related to electric motors and generators – from its own range of wires to wind turbine generators.

We are able to rely on comprehensive expertise and a vertical range of manufacture which enables even the most challenging customer wishes to become reality.

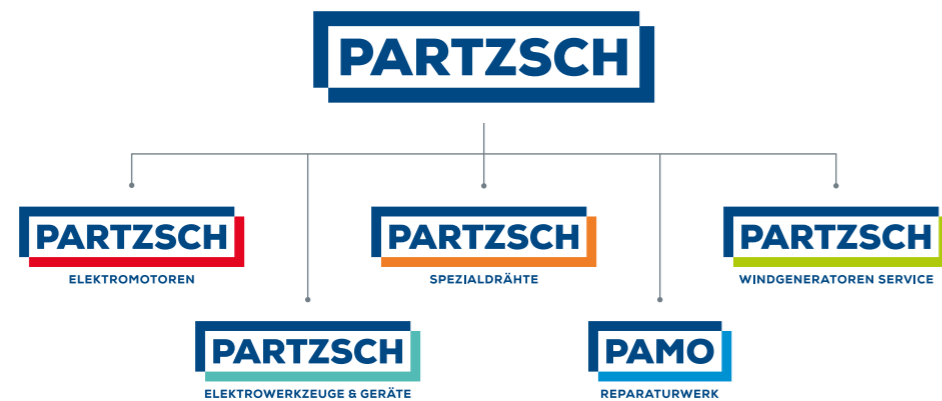

SERVICE MAKES THE DIFFERENCE

Our qualified team would be pleased to elaborate solutions together with you, taking into account your particular product requirements. Contact us! We are looking forward to hearing from you.

FAST AND FLEXIBLE

Our central location and excellent links to the A14 motorway guarantee fast and flexible deliveries.

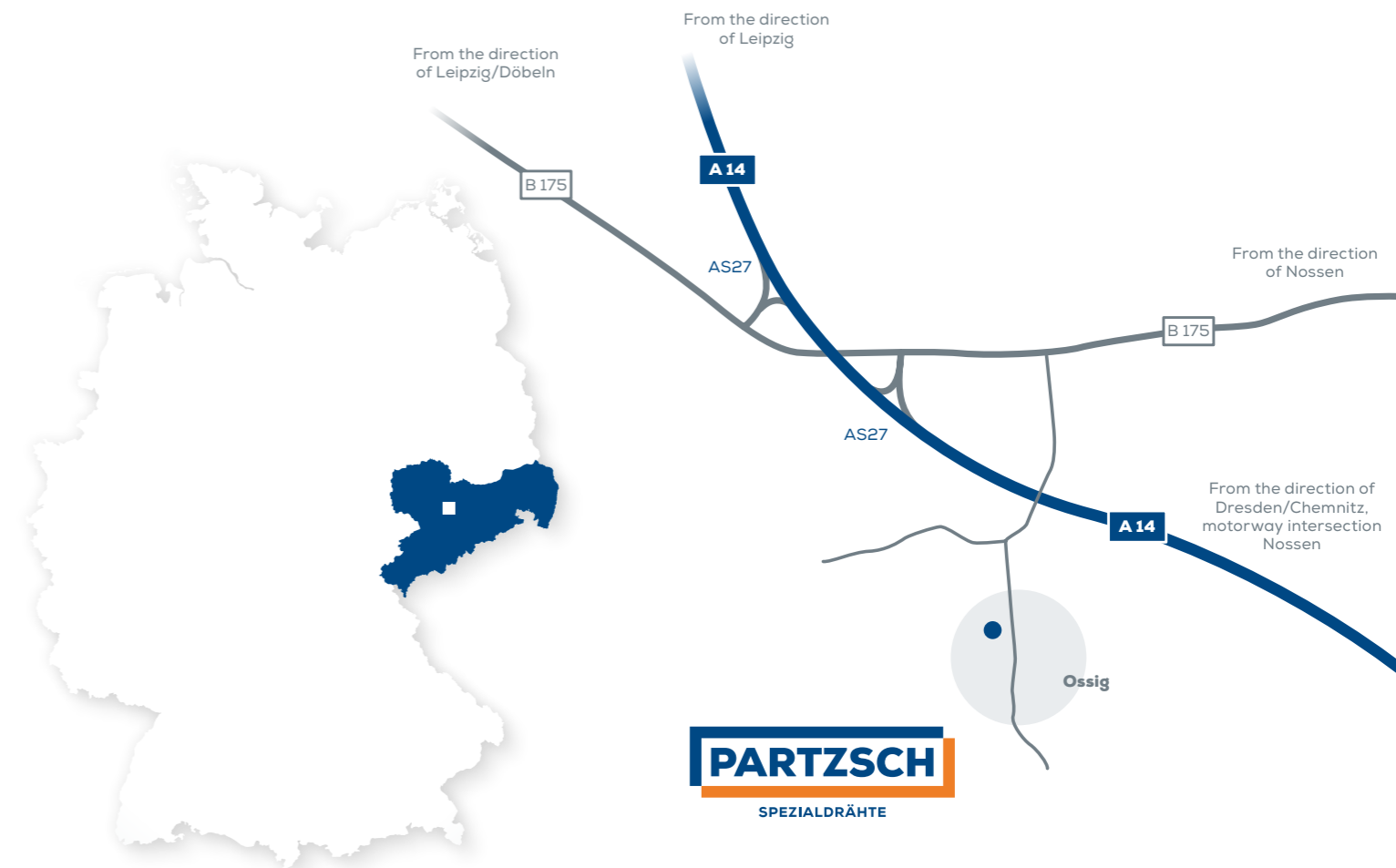

PARTZSCH

SPEZIALDRÄHTE

PARTZSCH Spezialdrähte GmbH

Ossig Nr. 9 · D-04741 Rosswein
Telephone +49 (0) 34322 6681-10 · Fax +49 (0) 34322 6681-11
spezialdraehte@partzsch.de

www.partzsch.de